

acaia

Acaia | Lunar Operation Manual

Using Your Acaia Coffee Scale

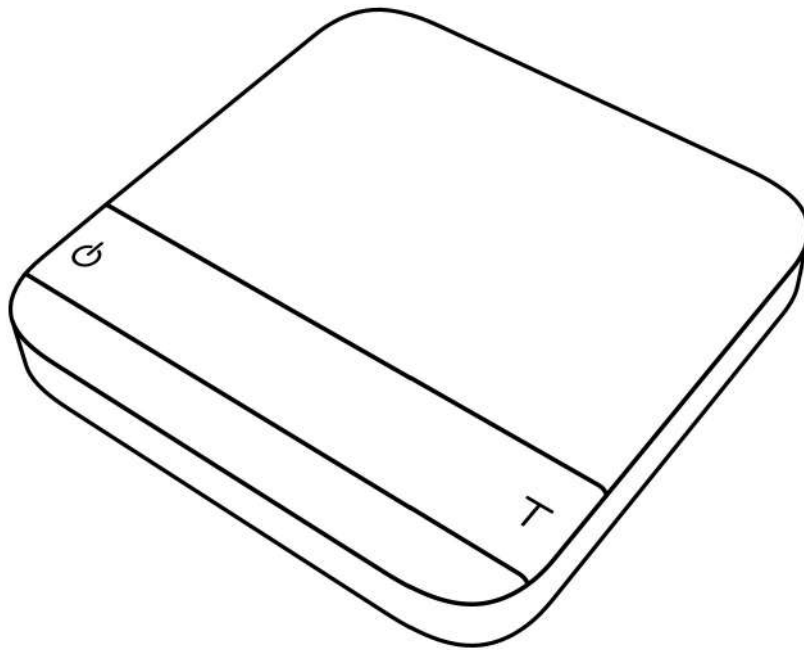

Identification

The instructions in this operation manual apply to the Acaia Lunar. You have purchased a quality precision weighing scale that requires handling with care. Make sure to read through this operation manual prior to using the scale.

Disclaimer

Calibrate your scale using a calibration weight of the appropriate tolerance (class F₁ or F₂). A scale can only be as accurate as the standard masses or weights used for calibration. For more details, please read Calibration Mode section in the operation manual.

CAUTION:

- 1. Any modification made without the consent of the manufacturer will result in the warranty being voided.**
- 2. Risk of explosion if battery is replaced by an incorrect type. Dispose of used batteries according to the instructions.**

Contents







4 Chapter 1: Scale at a Glance

- 4 Introduction
- 4 Specification
- 5 Scale Overview
- 6 Accessories
- 6 Buttons
- 7 LED Indicators
- 7 Battery Charge







8 Chapter 2: Getting Started

- 8 Preparation
- 9 Charging and Setup

10 Chapter 3: Basics

- 10 Basic Operations
- 11 Mode 1 - Weighing Only Mode
- 12 Mode 2 - Dual Display Mode
- 13 Mode 3 - Timer Starts with Flow Mode 
- 15 Mode 4 - Auto-Tare Timer Starts with Flow Mode  
- 17 Mode 5 - Auto-Tare Auto-Start Timer Mode  
- 19 Mode 6 - Auto-Tare Mode 

21 Chapter 4: Configuration

- 21 Accessing the Lunar's Settings
- 22 Diagram of the Settings Menu
- 23 Sleep Timer Setting
- 23 Zero Tracking Setting
- 23 Key Sound Setting
- 24 Zero Range Setting
- 24 Weighing Filter Setting
- 24 Default Unit Setting
- 25 Weighing Resolution Setting
- 25 Weighing Only Mode Setting
- 25 Dual Display Mode Setting
- 25 Timer Starts with Flow Mode  Setting
- 26 Auto-Tare Timer Starts with Flow Mode   Setting
- 26 Auto-Tare Auto-Start Timer Mode   Setting
- 26 Auto-Tare Mode  Setting
- 26 Bluetooth Setup Setting
- 27 Battery Saving
- 27 Pre-Infusion Time Out
- 27 Auto-Start Sensitivity
- 28 Auto-Reset
- 28 Reset to Default Setting

29 Appendix

- 29 Appendix A. Smart Calibration
- 30 Appendix B. Display Codes

Chapter 1: Scale at a Glance

Introduction

Thank you for choosing one of our scales. The Acaia Lunar is designed and manufactured to the most rigorous standard to give you the best coffee brewing experience. Start by checking that your Acaia Lunar box contains all the parts listed below:

- | | |
|----------------------------|----------------------|
| ● Acaia Lunar | ● Micro USB cable |
| ● Acaia Scale Weight 100 g | ● Heat Resistant Pad |

Next, follow the instructions in the Preparation and Installation sections in the manual to get started.

To take an advantage of its many features, carefully read through the operation manual containing step-by-step procedures, examples, and other information.

Warning: Incorrect handling of this product could possibly result in personal injury or physical damage.

Specifications

Aprox. Weight	270g		
Capacity	2000g / 70.54oz		
Measuring Units	g , oz		
Weighing Range	Maximum capacity	2000.0g	70.540oz
	Division	0.1g	0.002 oz
	Reference division	0.01g	0.0005 oz
Indication Limit	2060.00g / 72.6600oz		
Unit Dimensions	105mm(W) x 105mm (L) x 15.5mm (H)		
Electrical Requirements	5V/500mA		
Power and Battery	Lithium-ion rechargeable 3.7V 1100mA		
Display	8 digit LED		
Top	Aluminum construction with acrylic window, touch sensitive buttons		
Bottom	Aluminum construction		
Connectivity	Bluetooth 4.0		
Linearity	+/- 0.2g		

Scale Overview

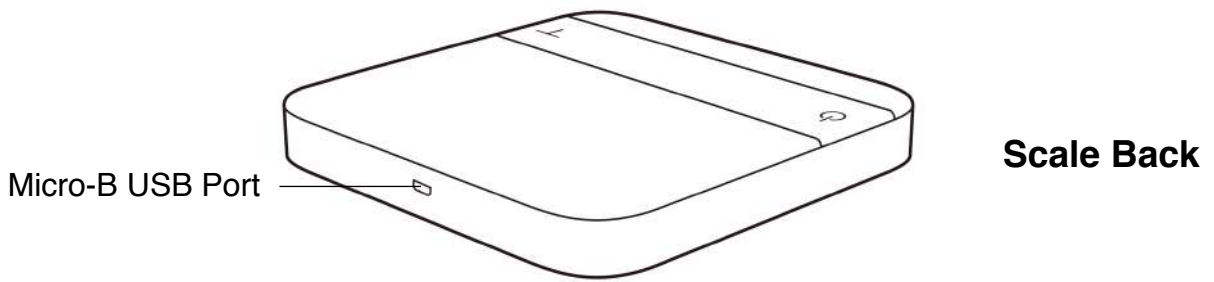
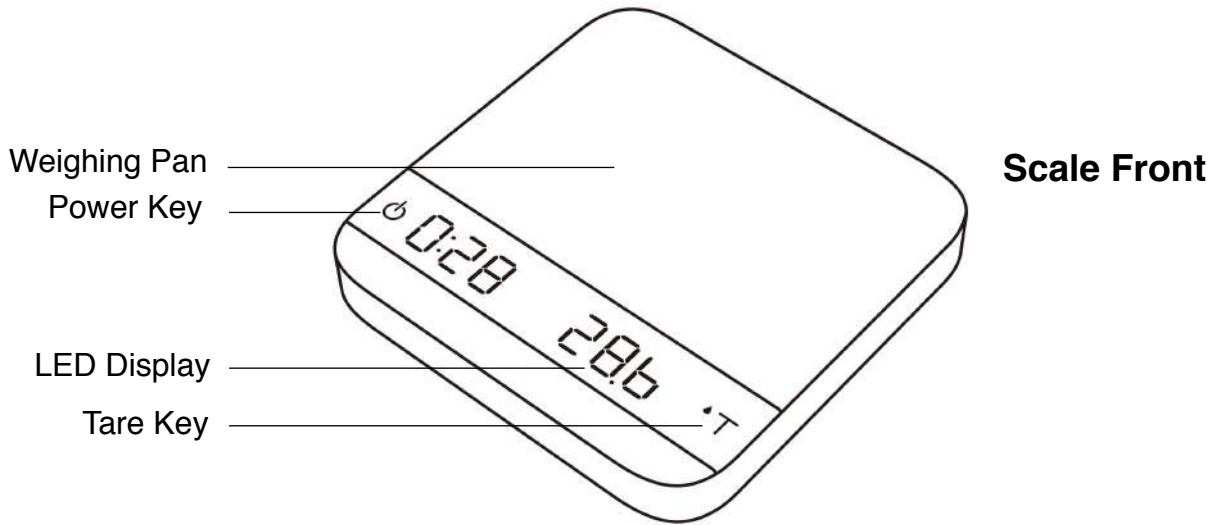

Accessories

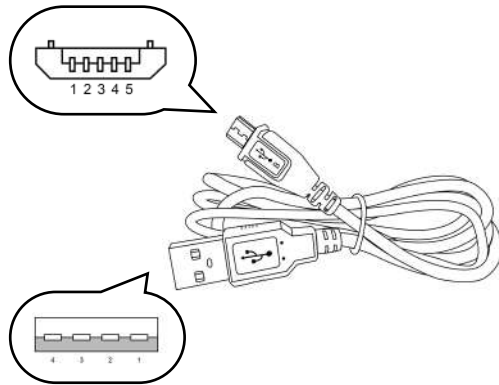

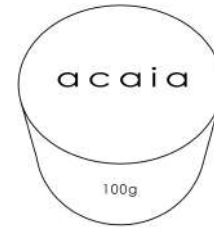

**Micro USB
Charging Cable**



**Acaia Scale Weight
100 g**

Buttons

	Function	Example
	Turn on	Press and hold for 0.5 seconds to turn on the scale.
	Turn off	Double tap to turn the scale off.
	Switch mode	While the scale is turned on, press and hold for 1 second to switch modes: Weighing Only Mode / Dual Display Mode / Auto Start Modes.
	Start / pause / reset timer	While in Dual Display Mode, tap to start/pause/reset timer. While in Auto Start Modes, tap to reset timer while the timer is paused.
	Back	While in the Settings Menu, tap to go back to Weighing Only Mode(Default Setting).
	Tare	While in Weighing Mode/ Dual Display Mode/ Auto Start Modes, tap to perform tare operation.
	Tare and reset timer	While in Auto Start Modes, double tap Tare Button to zero weight and reset timer.
	Switch option	While in the Settings Menu, press to switch options.
	Confirm	While in the Settings Menu, press and hold for 1 second to confirm the option selected.
	Enter calibration mode	While in Weighing Only Mode, tap rapidly 6-7 times to enter Calibration Mode.

* Please see **Chapter 3: Basics** for more details.

LED Indicators

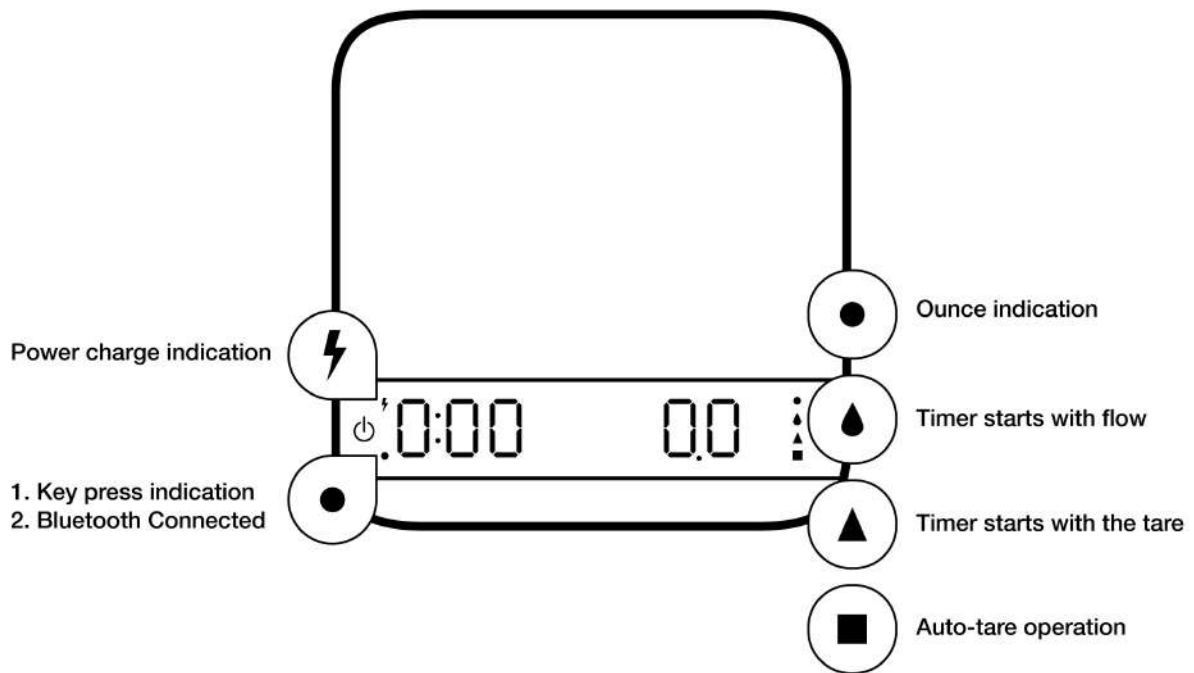

Battery Charge

- Charge the battery by plugging the USB cable to any power supply listed below:
 - A computer USB port
 - A 5V at 1A cell phone charger with a micro USB connector
 - An automotive 5V cell phone charger with a USB port or a Micro USB cable
- It takes 1-2 hours to fully charge the battery. You can charge the battery more frequently so that it will never run out of charge.
- Battery percentage can be viewed in Acaia Apps.
- It is not recommended to let the battery run out completely before charging.
- *Please note: Using a “fast-charging” charging block or charging hub (a charging block/hub delivering over 5v at 1A) could damage your Acaia scale’s circuit board.

Chapter 2: Getting Started

Preparation

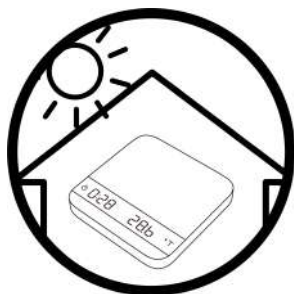

- The scale is intended for indoor use.

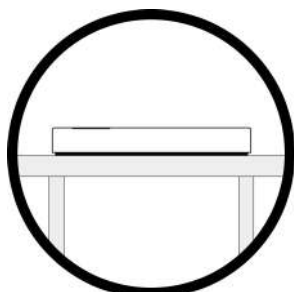

- Select a workplace that is stable, vibration-free, and level.



- Do not operate the scale near any equipment which contains magnets.

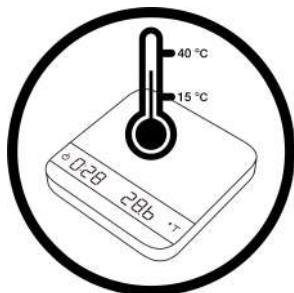

- Avoid places where room temperatures are unstable. Room temperature above 40°C or below 15°C may result in weighing inaccuracy.

Charging and Setup

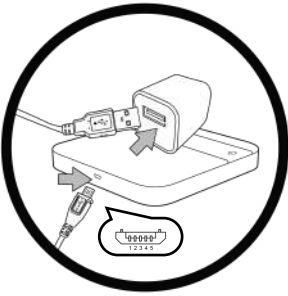

- To charge the scale, plug the USB cable into the Micro-B USB port located on the back panel of the scale.



- Press power button for 0.5 seconds to turn on the scale.

Chapter 3: Basics

Basic Operations

Action	Operation
Turn On Scale	Press and hold power button
Turn Off Scale	Double tap power button
Switch Mode	Press and hold power button while scale is on
Tare Weight	Tap tare button

Modes **To Enable/Disable Modes Please see Chapter 4: Configuration.*

Mode 1 - Weighing Only Mode

Mode 2 - Dual Display Mode

Mode 3 - Timer Starts with Flow Mode () - Droplet



Mode 4 - Auto-Tare Timer Starts with Flow Mode ( ) - Droplet and Square

Mode 5 - Auto-Tare Auto-Start Timer Mode ( ) - Triangle and Square

Mode 6 - Auto Tare Mode () - Square

Status Icon

The following icons display on the right side of the LED display.

1. Droplet  : When the scale detects the flow of espresso, the timer starts. The timer will stop when the flow stops. **Please note: The flow detection mode is designed to detect the flow of espresso. The timer may not trigger when attempting to pour from a kettle.*
2. Triangle  : The scale performs auto-tare operation when placing a stable weight on the Lunar, and simultaneously starts the timer.
3. Square  : When placing a stable weight on the scale, the scale will perform the auto-tare operation.

Mode 1 - Weighing Only Mode

In the Weighing Only Mode, the scale will only display weight in either grams or ounces.

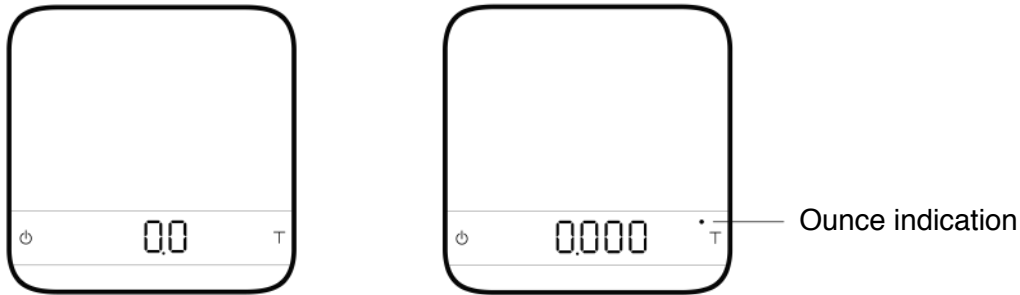

Display

- There are two different weighing units in Weighing Only Mode: grams and ounces. A dot will appear in the upper right of the LED display and the scale will read 0.000 when weighing in ounces, see the right image above.
- The readability is 0.1 g or 0.002 oz . For high resolution mode, the readability is 0.01 g or 0.0005 oz.
- Note: To change the weighing unit to either grams or ounces, please see **Chapter 4 Default Unit Setting** for more information.

Action	Operation
Tare Weight	Tap tare button
Switch Modes	Long press power button

Mode 2 - Dual Display Mode

In Dual Display Mode, the scale displays [0:00 0.0] with a timer (left) and weight (right).

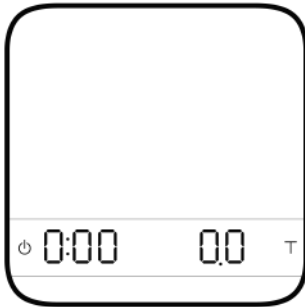

Display

- There are two different weighing units in Dual Display Mode: grams and ounces.
- The display range for grams is from [0.0] to [2000.0 g] (+/- 3%).
- The display range for ounces is from [0.000] to [70.540] (+/- 3%).
- If the weight exceeds 2000.00 grams, the scale will display [_ _ _ _]
- When weighing in grams the display shows [0:00 0.0].
- When weighing in ounces the display shows [0:00 0.000].
- Note: The maximum time that can be displayed is 9 minutes and 59 seconds. When the limit is reached, the timer still goes up until 999 minutes and 59 seconds. It can be observed by iOS/ Android App.

Action	Operation
Start/Stop/Reset Timer	Tap power button
Tare Weight	Tap tare button
Switch Mode	Press and hold power button

Mode 3 - Timer Starts with Flow Mode (♣) - Droplet

When the scale detects the flow of espresso, the timer starts. The timer will stop when the flow stops. This mode is designed to detect the slow trickle of a shot of espresso.*please note: The flow detection mode is designed to detect the flow of espresso. The timer may not trigger when attempting to pour from a kettle.

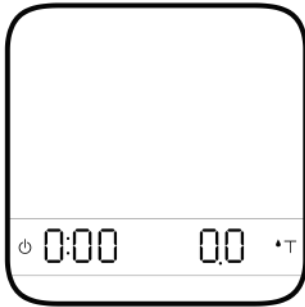

Display

- The LED display shows [0:00 0.0] with the timer on the left and the weight on the right in gram units.
- The LED display shows [0:00 0.000] with the timer on the left and the weight on the right in ounce units.
- The timer displays from [0:00] to [9:59] and then the timer will stop.

Action	Operation
Start/Stop/Reset Timer	The timer will start when flow is detected
Tare Weight	Tap tare button
Switch Mode	Press and hold power button
Stop Timer	The timer will stop when flow is no longer detected
Reset	Double tap tare button to reset the timer and to tare the weight at the same time

Mode Description

- The timer starts when the flow of espresso is detected.
- When the espresso flow stops, the timer stops.

1 The droplet icon indicates that you are in Auto-Liquid Timer Mode.

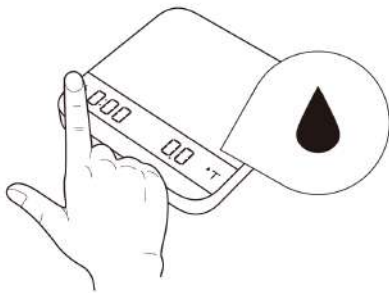

2 Placing a container on the scale will display its weight.



3 Tare the weight manually.

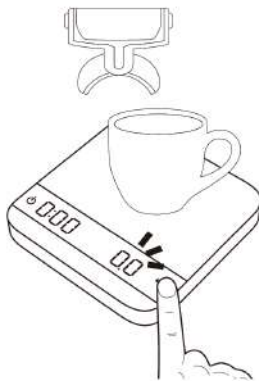

4 The timer starts when the flow of espresso is detected.



Mode 4 - Auto Tare Timer Starts with Flow Mode () - Droplet and Square

This mode is designed for baristas who would like to measure the time of the shot starting from the first few drops of espresso. When a stable weight is detected, the scale will perform the auto-tare operation. After the scale detects the espresso flow, the timer starts. The timer will stop when the espresso flow stops.

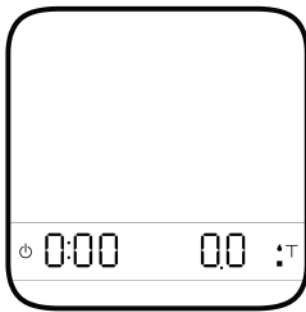

Display

- The LED display shows [0:00 0.0] with the timer on the left and the weight on the right in gram units.
- The LED display shows [0:00 0.000] with the timer on the left and the weight on the right in ounce units.
- The timer displays from [0:00] to [9:59] and then the timer will stop.

Action	Operation
Start/Stop/Reset Timer	The timer will start when flow is detected
Tare Weight	Tare function operates when the weight exceed 2 grams.
Switch Mode	Press and hold power button
Stop Timer	The timer will stop when flow is no longer detected
Reset	Double tap tare button to reset the timer and to tare the weight at the same time

Mode Description

- The auto-tare function operates when a stable weight placed on the scale.
- The timer will start automatically when the flow of espresso is detected.

1 This mode is designed for baristas who would like to measure the time of the shot starting from the first few drop of espresso.

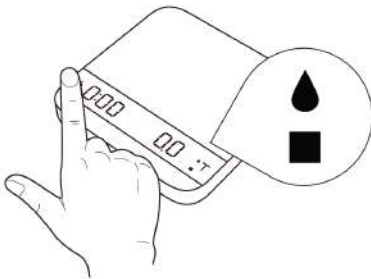

2 Place a stable weight on the scale.



3 The scale will perform the auto-tare function.



4 When the scale detects the espresso flow, the timer will start.



Mode 5 - Auto-Tare Auto-Start Timer Mode (▲ ■) - Triangle and Square

This mode is for baristas to measure the total time of a shot including the pre-infusion time. After placing a stable weight such as a cup on the scale, it performs the auto-tare operation and starts the timer.

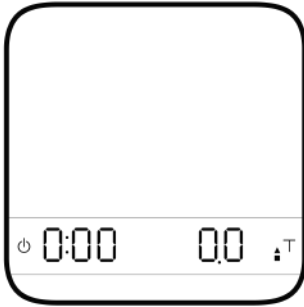

Display

- The LED display shows [0:00 0.0] with the timer on the left and the weight on the right in gram units.
- The LED display shows [0:00 0.000] with the timer on the left and the weight on the right in ounce units.
- The timer displays from [0:00] to [9:59] and then the timer will stop.

Action	Operation
Start/Stop/Reset Timer	The timer will start when a stable weight is placed on the scale
Tare Weight	Tare function starts when a stable weight is placed on the scale
Switch Mode	Press and hold power button
Stop Timer	The timer will stop when flow is no longer detected
Reset	Double tap tare button to reset the timer and to tare the weight at the same time

Mode Description

- The auto-tare function performs once a stable weight is detected, then the timer starts.
- The timer stops when the espresso flow stops.

1 This mode is for baristas who would like to measure the total time of a shot, including pre-infusion time.

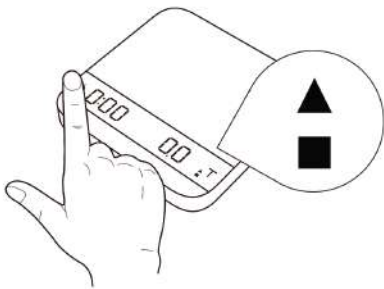

2 After placing a stable weight such as a cup on the scale, it will auto-tare and start the timer.



3 Measure the total time of a shot including the pre-infusion time.



4 When the espresso flow stops the timer stops.



Mode 6 - Auto-Tare Mode (■) - Square

In this mode, the scale will only perform auto-tare without automatically starting the timer. Put the cup on the scale and auto-tare will be performed. Pull the shot of espresso as usual. When the cup is removed from the scale, the display flashes the final beverage weight and also shows the tare weight of the cup. The weight resets after 30 seconds (to edit this reset time, see Chapter 4: Configuration to edit the setting `[Auto_rES]`).

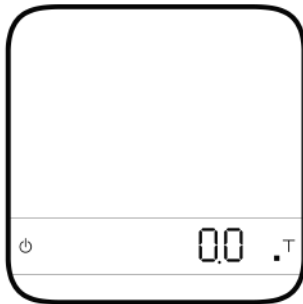

Display

- The LED display shows [0.0] with the weight on the right in gram units.
- The LED display shows [0.000] with the weight on the right in ounce units.

Action	Operation
Tare Weight	Tare function is performed when a stable weight is placed on the scale
Switch Mode	Press and hold power button
Stop Timer	Tap power button
Reset	Double tap tare button to reset the mode

Note:

1. In all three Auto Start Modes (Timer Starts With Flow Mode, Auto-Tare Timer Starts With Flow Mode and Auto-Tare Auto-Start Timer Mode), the timer will stop when the espresso flow stops.



2. In all Auto Start Modes, if you do not operate the scale for 30 seconds, it will reset timer and perform tare operation.

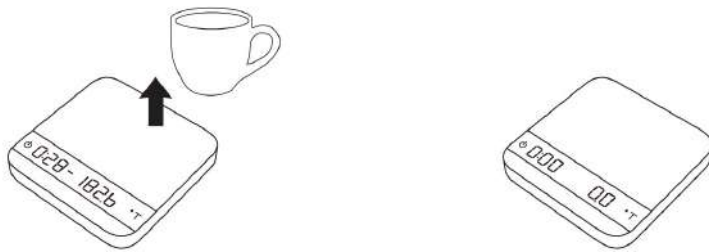

3. In all Auto Start Modes, the timer will stop when a negative weight (i.e. removal of cup) is detected.

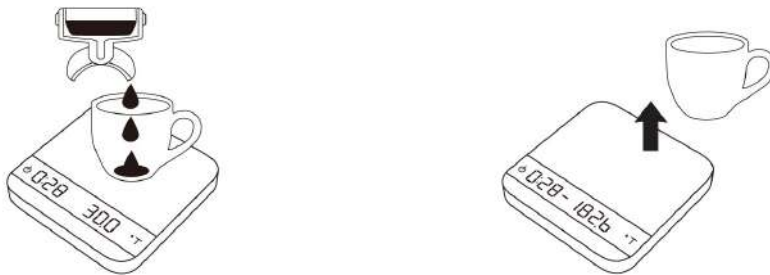

4. The scale will also display a previous stable weight that captures the coffee weight of the shot when you unloaded the cup.

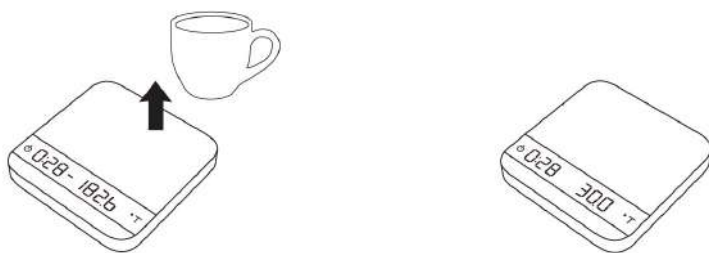

Chapter 4: Configuration

Accessing the Lunar's Settings

Steps to enter the Settings Menu

1. With the Lunar powered off, press and hold the power button. When the LED display shows [*ON*] and then [*SET*], release the power button and tap the tare button.
2. The scale will now display the first setting, [*SLEEP*].

Key Operations in the Settings Menu

1. Tap the tare button to scroll through the Settings Menu.
2. Press and hold the tare button to enter each setting's sub-menu
3. Tap the tare button to scroll through options in the individual settings sub-menu
4. Press and hold the tare button to save selection and exit the sub-menu
5. Tap the power button to exit the settings and return to the Lunar's Weighing Only modes.

Diagram of the Settings Menu

Setting	Display	Sub-Menu Options	Default
Sleep Timer	<i>SLEEP</i>	5, 10 ,20, 30, 60, Off	5
Zero Tracking	<i>trAcE</i>	0.5d, 1d, 2d, 3d, Off	1d
Key Sound	<i>bEEP</i>	On, Off	On
Zero Range	<i>0.rAGE</i>	2, 100	100
Weighing Filter	<i>Fi lT</i>	2, 4, 6, 8, 16, 32, 64, 128	16
Default Weighing Unit	<i>Uni t</i>	Gram, Ounce	Gram
Weighing Mode	<i>ModE_1</i>	On, Off	On
Dual Display Mode	<i>ModE_2</i>	On, Off	On
Timer Starts with Flow Mode 	<i>ModE_3</i>	On, Off	On
Auto-Tare Timer Starts with Flow Mode  	<i>ModE_4</i>	On, Off	On
Auto-Tare Auto-Start Timer Mode  	<i>ModE_5</i>	On, Off	On
Auto-Tare Mode 	<i>ModE_6</i>	On, Off	On
Bluetooth On/Off	<i>bt_SEt</i>	On, Off	On
Battery Saving	<i>bAttSvE</i>	30 ,90 ,180 ,OFF	90
Pre-infusion Timeout	<i>PrE_1 nFu</i>	10, 30, 60, 120	60
Auto-Start Sensitivity	<i>SEnSE</i>	0.1g, 0.2g, OFF	OFF
Auto-Reset	<i>Auto_rES</i>	OFF, 10, 30	30
Reset To Default	<i>rESEt.d</i>	No, Yes	

Sleep Timer Setting [*SLEEP*]

1. Sleep Timer Settings can also be configured in the Acaia Apps.
2. The number indicates the amount of time before the scale automatically powers off. For example, when 10 is selected, the scale powers off after 10 minutes of being idle, if the scale is disconnected from all mobile devices.
3. Tap the tare button to toggle through the options.
4. Press and hold the tare button for 1 second until the next setting, [*TARE*], is shown on the LED to confirm the selected option.

Zero Tracking Setting [*TARE*]

1. Zero Tracking is a function for maintaining the zero indication within certain limits automatically.
2. OFF: It is not recommended to turn off the Zero Tracking because the zero indication would drift easily as room temperature changes.
3. 0.5 d~3 d: For example, for standard resolution each division is 0.1 g, 3 d = 0.3 g. When Zero Tracking is set to be 3 d, any initial weight between +/- 0.3 g on the weighing pan would be zeroed out gradually.
4. 2 d is recommended in general for the Acaia Lunar.
5. Press and hold tare button for 1 second until the next setting, [*BEEP*], is shown on the LED to confirm the selected option.

Key Sound Setting [*BEEP*]

1. Key Sound Settings can also be configured in the Acaia apps.
2. Set the Key Sound function off to turn off the beeping sound or on to turn on the beeping sound.
3. Press and hold tare button for 1 second until the next setting, [*DRANGE*], is shown on the LED to confirm the selected option.

Zero Range Setting [*0.r RnGE*]

1. The Zero Range setting determines the range for which the tare button executes zero operation instead of tare operation.
2. When Zero Range is set to 2, the range for zero-setting will be 2% of the capacity, i.e., +/- 40 g for Acaia Lunar. By pressing the tare button, any weight within +/- 40 g is zeroed out by zero operation while any weight lays outside the range is tared out by tare operation.
3. If Zero Range is set to 100, the range for zero-setting will be 100% of the capacity, i.e., +/- 2 kg for Acaia Lunar. Therefore, instead of tare operation, zero operation would be executed in this setting whenever tare button is pressed.
4. Press and hold tare button for 1 second until the next setting, [*Filt*], is shown on the LED to confirm the selected option.
5. Notice: The difference between zero operation and tare operation is that zero operation would simply ignore the weight and display as 0 while tare operation would deduct the weight from weighing result. However, zero operation does not increase the scale capacity.

Weighing Filter Setting [*Filt*]

1. The Weighing Filter Setting determines the speed that the load receptor responds to weight and determines the weighing value. The larger the number, the more stable but slower the weighing result will be. The number shown on LED display indicates the current filter setting
2. Press tare button to change the parameter.
3. Press and hold tare button for 1 second until the next setting, [*Unit*] is shown on the LED to confirm the selected parameter.

Default Unit Setting [*Unit*]

1. The Default Weighing Unit is set to grams if [*g*] is selected and ounce if [*oz*] is selected.
2. Tap the tare button to switch the Default Weighing Unit between grams and ounces.
3. Press and hold tare button for 1 second until [*Reset*] is shown on the LED to confirm the selected option.

Weighing Resolution Setting [*rESOL*]

1. The default Weighing Resolution is set to [*default*]: the division is 0.1 g /0.002 oz.
2. Tap tare button to switch the weighing resolution between [*default*] and [*high*].
3. When the Weighing Resolution is set to high, division will be 0.01 g/0.0005 oz. The default display will show [*0.00*] when the scale is set to grams, and [*0.0000*] for ounces in Weighing Mode.
4. Press and hold tare button for 1 second until [*node_1*] is shown on the LED to confirm the selected option.
5. Note: After setting Weighing Resolution to high, the default display will show [*0:00 0.00*] with timer in Dual Display Mode and Auto Start Modes.

Weighing Only Mode Setting [*node_1*]

1. The default Weighing Only Mode Setting is set to ON, which means this mode is enabled.
2. ON: The Weighing Mode is enabled.
3. OFF: The Weighing Mode is disabled.
4. Press and hold tare button for 1 second until [*node_2*] is shown on LED to confirm the selected option.

Dual Display Mode Setting [*node_2*]

1. By default, the Dual Display Mode Setting is set to ON, which means this mode is enabled.
2. ON: The Dual Display Mode is enabled.
3. OFF: The Dual Display Mode is disabled.
4. Press and hold tare button for 1 second until [*node_3*] is shown on LED to confirm the selected option.

Timer Starts with Flow Mode Setting [*node_3*]

1. By default, the Timer Starts with Flow Mode with Droplet Setting is set to ON, which means this mode is enabled.
2. ON: The Timer Starts with Flow Mode with Droplet is enabled.
3. OFF: The Timer Starts with Flow Mode with Droplet is disabled.
4. Press and hold tare button for 1 second until [*node_4*] is shown on LED to confirm the selected option.

Auto-Tare Timer Starts with Flow Mode ♠ ■ Setting [*node_4*]

1. The default Auto-Tare Timer Starts with Flow Mode with Droplet and Square Setting is set to ON, which means this mode is enabled.
2. ON: The Auto-Tare Timer Starts with Flow Mode with Droplet and Square is enabled.
3. OFF: The Auto-Tare Timer Starts with Flow Mode with Droplet and Square is disabled.
4. Press and hold tare button for 1 second until [*node_5*] is shown on LED to confirm the selected option.

Auto-Tare Auto-Start Timer Mode ▲ ■ Setting [*node_5*]

1. The default Auto-Tare Auto-Start Timer Mode with Triangle and Square Setting is set to ON, which means this mode is enabled.
2. ON: The Auto-Tare Auto-Start Timer Mode with Triangle and Square is enabled.
3. OFF: The Auto-Tare Auto-Start Timer Mode with Triangle and Square is disabled.
4. Press and hold tare button for 1 second until [*node_6*] is shown on LED to confirm the selected option.

Auto-Tare Mode ■ Setting [*node_6*]

1. The default Auto-Tare Mode with Square is set to ON, which means this mode is enabled.
2. ON: The Auto-Tare Mode with Square is enabled.
3. OFF: The Auto-Tare Mode with Square is disabled.
4. Press and hold tare button for 1 second until [*bt_5EE*] is shown on LED to confirm the selected option.

Bluetooth Setup Setting [*bt_5EE*]

1. OFF: The Bluetooth is disabled. The scale does not allow any Bluetooth connection.
2. ON: The Bluetooth is enabled. The scale allows Bluetooth connection. User may connect the scale with Acaia Apps.
3. Press and hold tare button for 1 second until [*BT5BE*] is shown to confirm the modification.

Battery Saving [*BATTERY*]

1. Save ~20% of your battery by dimming the display after some time. It'll return to its original brightness when the scale senses objects on it.
2. The number indicates the amount of time before the scale enters battery saving mode.
3. Tap the tare button to toggle through the options.
4. Press and hold tare button for 1 second until the next setting, [*PRE-INFU*], is shown on LED to confirm the selected option.

Pre-Infusion Time Out [*PRE-INFU*]

1. Determines when the scale times out in all three of the Auto-Start modes. This is most useful for long pre-infusion times and resolves the timeout that sometimes happens for slow pre-infusion times.
2. The number indicates the time in seconds it will take for the scale to reset if no espresso flow or weight is detected.
3. Tap the tare button to toggle through the options.
4. Press and hold tare button for 1 second until the next setting, [*SENS*], is shown on the LED to confirm the selected option.

Auto-Start Sensitivity [*SENS*]

1. Minimum weight is decreased for more sensitivity. This is ideal for slower espresso shots in the droplet icon modes. Stability depends on environmental noise. The previous firmware started the timer at ~0.6 g into an espresso shot.
2. The number indicates the sensitivity of flow detection in the droplet icon modes. Smaller value indicates higher sensitivity, but is recommended only for stable working environment.
3. Tap the tare button to toggle through the options.
4. Press and hold tare button for 1 second until the next setting, [*AUTO-RES*], is shown on the LED to confirm the selected option.

Auto-Reset [*Auto_rES*]

1. After a cup is removed, the timer will automatically reset. This gives you options on how long to wait for the reset. This setting enables the user to pull successive shots of espresso quickly in the three auto-start modes.
2. The number indicates the timeout value of timer reset after a cup is removed.
3. Tap the tare button to toggle through the options.
4. Press and hold tare button for 1 second until the next setting, [*rESEt.d*], is shown on the LED to confirm the selected option.

Reset To Default Setting [*rESEt.d*]

1. Select [*4ES*] to set all setting to default value.
2. Press and hold tare button for 1 second until [*SLEEP*] is shown on the LED to reset all settings to default.

Appendix A. Smart-Calibration

If you decide to calibrate your scale, it will only be as good as the accuracy of the calibration weights you use.

*Note : If you use weights other than Acaia Weights, we recommend standard weights with class F₁ or F₂.

Calibration Mode

1. While the scale is in Weighing Only Mode and the weighing unit is in grams, tap the tare button quickly multiple times until LED display shows [*CAL*] and then [*100.00*].
2. Place the 100 g Acaia calibration weight that came with your Lunar in the middle of the weighing platform and wait for the scale to execute calibration procedure.
3. The LED display shows [*_End_*] when the calibration procedure is completed. You may remove the calibration weight when completed.

Note:

1. If your Weighing Only Mode is disabled, please refer to **Chapter 4: Weighing Mode Setting** to turn on.
2. If you use weights other than Acaia Weights, we recommend F1 or F2 class weights at 100, 300, 500, 1000, or 1500 grams.

- 1 Turn on the Acaia scale.

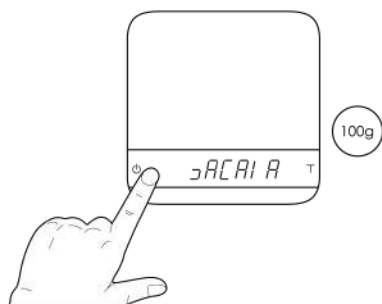

- 2 Make sure the scale is in Weighing Only Mode and the unit is set to 'gram', then tap the 'T' button rapidly.

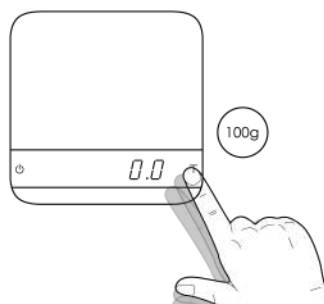

- 3 Keep tapping the 'T' button until the 'CAL' is shown on the display.

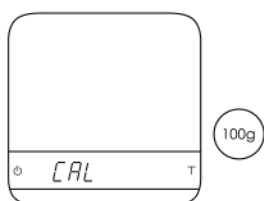

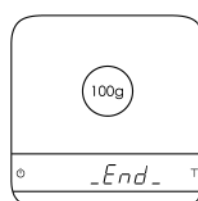

- 4 Place a 100 g weight on the scale and wait until the display shows '_End_'. Calibration is now complete!



Appendix B. Display Codes

Error Code List

Error Code	Description
100	Code error
101	EEPROM error
102	AD read error
	Over load: the weight is over the maximum capacity.
	Under load: the weight is under the minimum capacity.
303	Unable to make zero point, for the initial weight exceeds the limit (50% of capacity).
304	Weight calibration error.
904	Password error (the default password is 0000)
_H2O	Water in the power button
H2O_	Water in the tare button
H2O	Water in the power button and tare button

Others

Display Code	Description
UPdAtE	The scale is in update mode. Note: If you want to leave update mode, please plug the scale's USB to a power source.

Copyright

The operation manual is protected by copyright. All rights reserved. No part of the operation manual may be reproduced, processed, duplicated or published in any form by photocopying, microfilming, reprinting or any other method, in particular electronic means, without the written agreement of Acaia.

© Acaia, Cupertino, CA, 2019.